

1 Symbol External 45° Sofa 2 Symbol 90° Sofa 3 Symbol 180° Bench 4 Hudson Coatstand

symbol

Modular Seating



8 Symbol 2 Seater No Arms 9 Symbol 2 Seater Right Arm
10 Symbol 2 Seater Left Arm 11 Trace Coffee Table

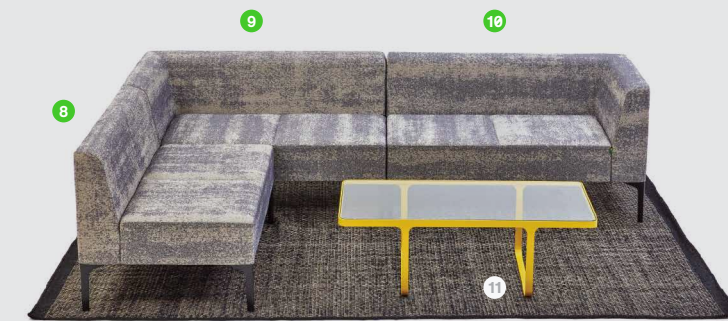

Symbol Modular Seating designed by naughtone 2016

About Symbol

The Symbol seating range has a pared down aesthetic, designed to feel like part of the architecture and provide building blocks for furniture landscapes. Symbol has a firm upright sit and compact dimensions, making it perfect for modern commercial environments where space is at a premium.

Compliance

- SCS Indoor Advantage™ Gold Certificate
- FSC®certified products available upon request
- naughtone is FISP and ISO14001 certified
- Our seating is designed to meet or exceed all EN performance requirements per BS EN 16139:2013

Sizes All dimensions quoted are rounded to the nearest 5mm or nearest 1/2 inch



SYM1ST
Symbol Single Stool
mm
W510 D510 H410 Seat 410
inch
W20 D20 H16 Seat 16

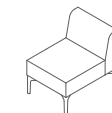

SYM1NA
Symbol Chair no arms
mm
W510 D690 H685 Seat 410
inch
W20 D27 H27 Seat 16

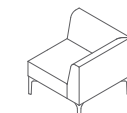

SYM11A
Symbol Corner Chair 1 arm
mm
W690 D690 H685 Seat 410
inch
W27 D27 H27 Seat 16

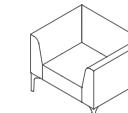

SYM12A
Symbol Chair 2 arms
mm
W870 D690 H685 Seat 410
inch
W34.5 D27 H27 Seat 16

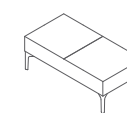

SYM2BEN
Symbol 2 Seater Bench
mm
W1020 D510 H410 Seat 410
inch
W40 D20 H16 Seat 16

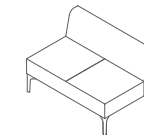

SYM2NA
Symbol 2 Seater no arms
mm
W1020 D690 H685 Seat 410
inch
W40 D27 H27 Seat 16

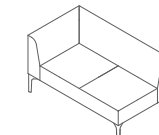

SYM2RA
Symbol 2 Seater right arm
mm
W1200 D690 H685 Seat 410
inch
W47 D27 H27 Seat 16

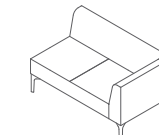

SYM2LA
Symbol 2 Seater left arm
mm
W1200 D690 H685 Seat 410
inch
W47 D27 H27 Seat 16

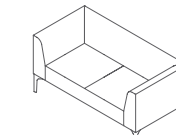

SYM22A
Symbol 2 Seater 2 arms
mm
W1380 D690 H685 Seat 410
inch
W54.5 D27 H27 Seat 16

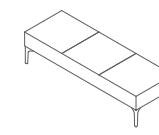

SYM3BEN
Symbol 3 Seater Bench
mm
W1530 D510 H410 Seat 410
inch
W60 D20 H16 Seat 16

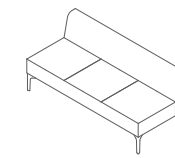

SYM3NA
Symbol 3 Seater no arms
mm
W1530 D690 H685 Seat 410
inch
W60 D27 H27 Seat 16

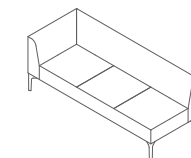

SYM3RA
Symbol 3 Seater right arm
mm
W1710 D690 H685 Seat 410
inch
W67.5 D27 H27 Seat 16

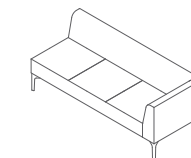

SYM3LA
Symbol 3 Seater left arm
mm
W1710 D690 H685 Seat 410
inch
W67.5 D27 H27 Seat 16

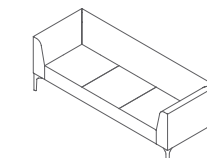

SYM32A
Symbol 3 Seater 2 arms
mm
W1890 D690 H685 Seat 410
inch
W74.5 D27 H27 Seat 16

Base Options



White / Black Steel Legs
Standard



RAL Powder Coated Legs
naughtone Colours

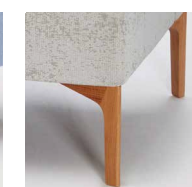

Solid Oak / Walnut Legs

Other Options

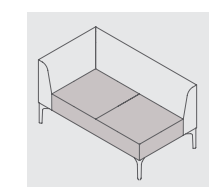

Two Tone
Backrest and Arms / Seat

- 1 Symbol 2 Seater Right Arm
- 2 Symbol 90° Curve Sofa
- 3 Symbol 2 Seater No Arms
- 5 Symbol 2 Seater Left Arm
- 6 Always Lounge Chair
- 7 Trace Coffee Table

symbol

Modular Seating

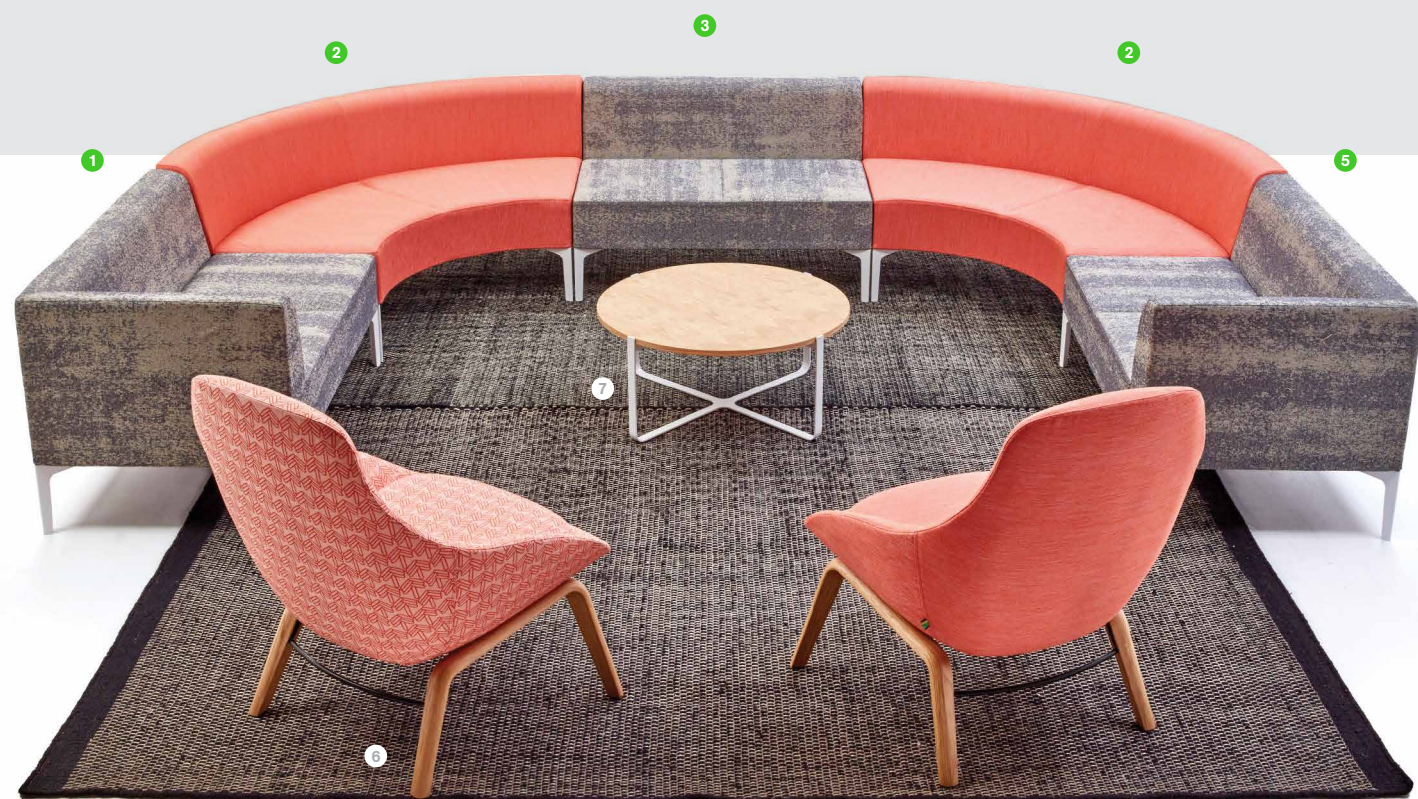

- 7 Symbol 180° Bench
- 8 Symbol External 45° Curved Sofa
- 9 Symbol 45° Curved Seat



Symbol Modular Seating designed by naughtone 2016

About Symbol

The Symbol seating and table range has a pared-down aesthetic, designed to feel like part of the architecture and provide building blocks for furniture landscapes.

Symbol has a firm upright sit and compact dimensions and with the addition of the upholstered table, is perfect for modern commercial environments where space is a premium and the furniture must look after itself.

Available with a wide range of leg options as standard and naughtone's wide fabric selection, Symbol is the perfect base for a commercial furniture plan.

Compliance

- SCS Indoor Advantage™ Gold Certificate
- FSC®certified products available upon request
- naughtone is FISP and ISO14001 certified
- Our seating is designed to meet or exceed all EN performance requirements per BS EN 16139:2013

Sizes All dimensions quoted are rounded to the nearest 5mm or nearest 1/2 inch

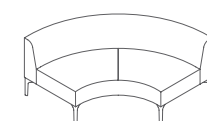

SYM90D
Symbol 90° Curve Sofa
mm
W 1825 D 865 H 685 Seat 410
inch
W 72 D 34 H 27 Seat 16

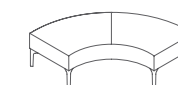

SYM90BEN
Symbol 90° Curve Bench
mm
W 1570 D 685 H 410 Seat 410
inch
W 62 D 27 H 16 Seat 16

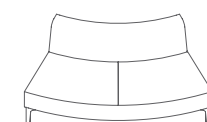

SYM45D
Symbol External 45° Curve Sofa
mm
W 1200 D 690 H 685 Seat 410
inch
W 47 D 27 H 27 Seat 16

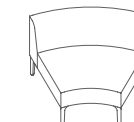

SYM45D
Symbol 45° Curve Seat
mm
W 1020 D 690 H 685 Seat 410
inch
W 40 D 27 H 27 Seat 16

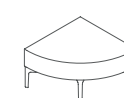

SYMQBEN
Symbol Quarter Circle Bench
mm
W 690 D 690 H 410 Seat 410
inch
W 27 D 27 H 16 Seat 16

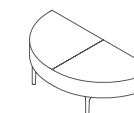

SYM180BEN
Symbol 180° Bench
mm
W 1380 D 410 H 410
inch
W 54.5 D 16 H 16



SYM45BEN
Symbol 45° Curve Bench
mm
W 1020 D 510 H 410 Seat 410
inch
W 40 D 20 H 16 Seat 16

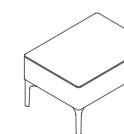

HATSYMTREC
Hatch / Symbol Rectangular Table
mm
W 690 D 510 H 410
inch
W 27 D 20 H 16

Table Top Options



White / Black MFMD
with polished MDF edge



Oak Veneer
with polished MDF edge



Walnut Veneer
with polished MDF edge

Base Options



White / Black Steel Legs
Standard



RAL Powder Coated Legs
naughtone Colours



Solid Oak / Walnut Legs

Other Options

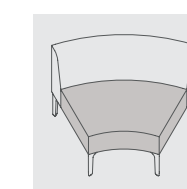

Two Tone
Backrest and Arms / Seat















Symbol Modular Seating Technical Specifications

Testing

Our chairs are designed to meet or exceed all EN performance requirements per **EN16139:2013**, which includes the following tests:

- Seat and back static load test
- Seat front edge static load test
- Vertical static load on back
- Foot rest and leg rest static load test
- Arm sideways static load test
- Arm downwards static load test
- Vertical upwards static load on arm rests
- Seat and back durability test
- Seat front edge durability test
- Leg forward static load test
- Leg sideways static load test
- Seat impact test
- Back impact test
- Arm impact test

Structural Testing Certifications

SYM12A

Symbol arm chair
BS EN16139:2013, level 1
 Static load 160kg

SYM2LA

Symbol 2 seat sofa with left arm
BS EN16139:2013, level 1
 Static load 320kg

SYM3NA

Symbol 3 seat sofa no arm
BS EN16139:2013, level 1
 Static load 320kg

SYM90D

Symbol 90° curve seat
BS EN16139:2013, level 1
 Static load 320kg

Flammability

The cold cure foam material has been tested to meet the following standards:

British standard
5852:2006 Part 2

California Technical Bulletin
117-2013

Italian standards
UNI 9175-CLASS 1.IM

The flammability standard of the covering fabric is dependent on the choice made by the customer, details of the flammability rating of specific fabrics can be found on supplier's websites listed below.

- www.kvadrat.dk
- www.camirafabrics.com
- www.butefabrics.com
- www.panaz.com
- www.maharam.com
- www.vescom.com
- www.ultrafabricsllc.com
- www.crestleather.com

Servicing



If a component is damaged and needs replacing then please email our team with an image of the damaged part and reference your order number, we will be happy to facilitate any replacements.

Warranty



naughtone offers a **10 Year** warranty across all products. Details on the terms and conditions of naughtones warranty can be found at naughtone.com/warranty

Symbol Single Seaters Technical Specifications

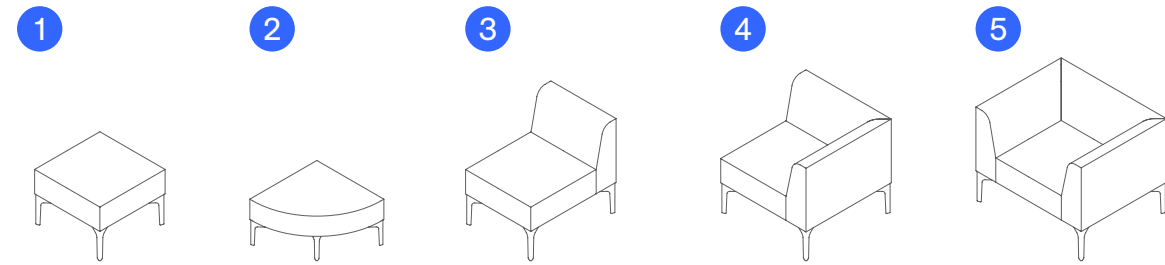

Product Code and Description <small>All dimensions quoted are rounded to the nearest 5mm or nearest 1/2 inch</small>	A Overall Width	B Overall Depth	C Overall Height	D Seat Height	E Distance between Legs (Front)	F Distance between Legs (Side)	G Weight
1 SYM1ST Symbol Single Stool	510 mm 20 in	510 mm 20 in	410 mm 16 in	410 mm 16 in	440 mm 17.5 in	440 mm 17.5 in	21.02 kg 46.3 lbs
2 SYMQBEN Symbol Quarter Circle Bench	690 mm 27 in	690 mm 27 in	410 mm 16 in	410 mm 16 in			11.4 kg 25.1 lbs
3 SYM1NA Symbol No Arms	510 mm 20 in	690 mm 27 in	685mm 27in	410 mm 16 in	440 mm 17.5 in	620 mm 24.5 in	34.5 kg 76.1 lbs
4 SYM11A Symbol Corner Chair 1 Arm	690 mm 27 in	690 mm 27 in	685mm 27in	410 mm 16 in	620 mm 24.5 in	620 mm 24.5 in	37.4 kg 82.5 lbs
5 SYM12A Symbol Chair 2 Arms	870 mm 34.5 in	690 mm 27 in	685mm 27in	410 mm 16 in	800 mm 31.5 in	620 mm 24.5 in	30.9 kg 68.1 lbs

Measuring Guide

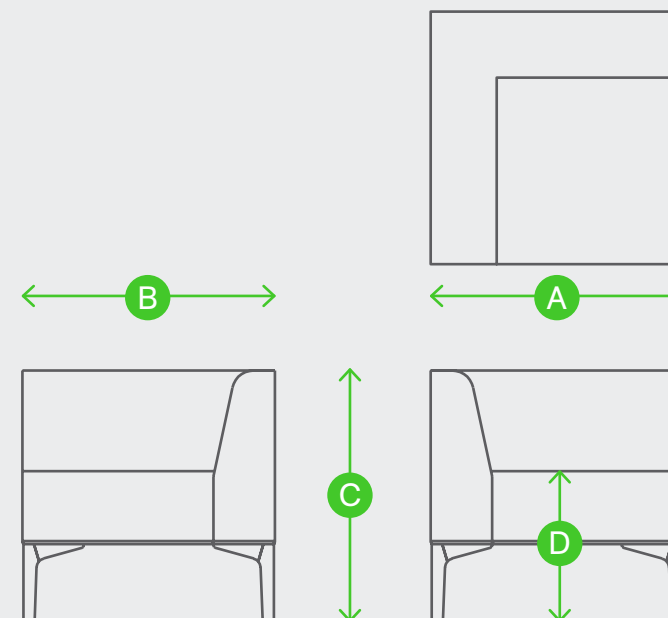

Symbol Two Seaters Technical Specifications

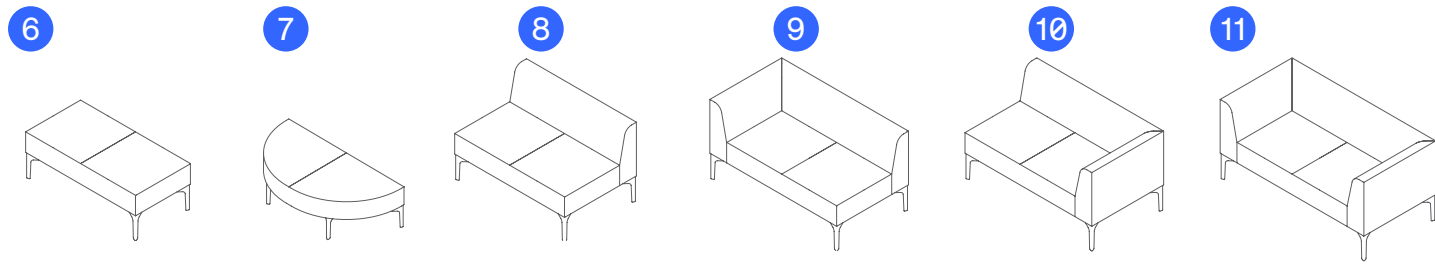

Product Code and Description <small>All dimensions quoted are rounded to the nearest 5mm or nearest 1/2 inch</small>	A Overall Width	B Overall Depth	C Overall Height	D Seat Height	E Distance between Legs (Front)	F Distance between Legs (Side)	G Weight
6 SYM2BEN Symbol 2 Seat Bench	1020 mm 40 mm	510 mm 20 mm	410 mm 16 mm	410 mm 16 mm	950 mm 37.5 in	620 mm 24.5 in	26.5 kg 58.4 lbs
7 SYM180BEN Symbol 180° Bench	1380 mm 54.5 in	690 mm 27 in	410 mm 16 in	410 mm 16 in			19.3 kg 42.5 lbs
8 SYM2NA Symbol 2 Seat No Arms	1020 mm 40 mm	690 mm 27 mm	685 mm 27 mm	410 mm 16 mm	950 mm 37.5 in	620 mm 24.5 in	33.8 kg 74.5 lbs
9 SYM2RA Symbol 2 Seat Right Arm	1200 mm 47 mm	690 mm 27 mm	685 mm 27 mm	410 mm 16 mm	1130 mm 44.5 in	620 mm 24.5 in	36.9 kg 81.4 lbs
10 SYM2LA Symbol 2 Seat Left Arm	1200 mm 47 mm	690 mm 27 mm	685 mm 27 mm	410 mm 16 mm	1130 mm 44.5 in	620 mm 24.5 in	36.9 kg 81.4 lbs
11 SYM22A Symbol 2 Seat 2 Arms	1380 mm 54.5 mm	690 mm 27 mm	685 mm 27 mm	410 mm 16 mm	1310 mm 51.5 in	620 mm 24.5 in	43 kg 94.8 lbs

Measuring Guide

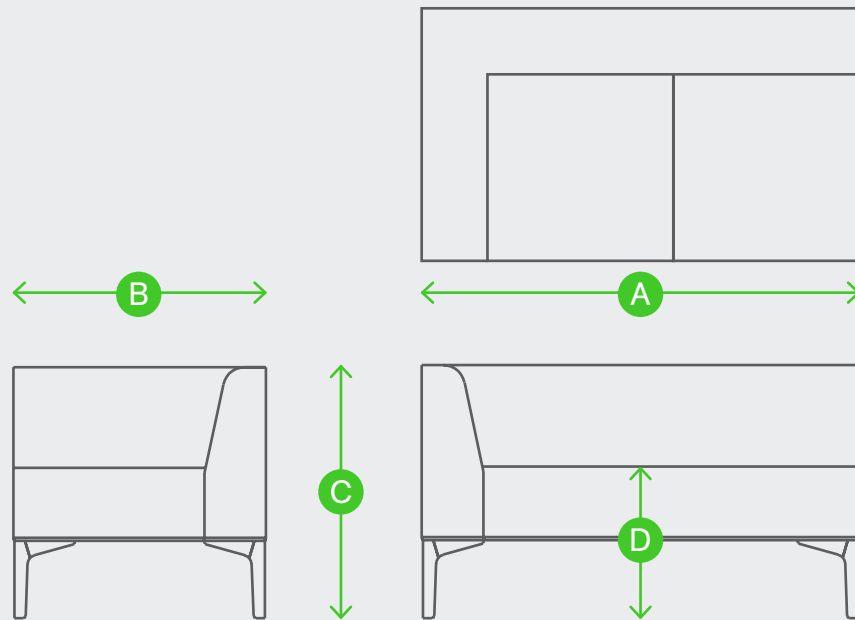

Symbol Three Seaters Technical Specifications

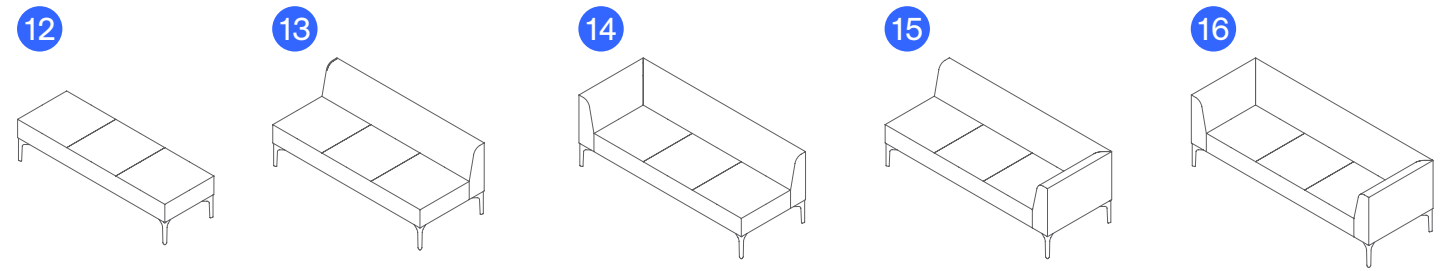

Product Code and Description <small>All dimensions quoted are rounded to the nearest 5mm or nearest 1/2 inch</small>	A Overall Width	B Overall Depth	C Overall Height	D Seat Height	E Distance between Legs (Front)	F Distance between Legs (Side)	G Weight
12 SYM3BEN Symbol 3 Seat Bench	1530 mm 60 mm	510 mm 20 mm	410 mm 16 mm	410 mm 16 mm	1445 mm 57 in	620 mm 24.5 in	29.9 kg 65.9 lbs
13 SYM3NA Hatch 3 Seat No Arms	1530 mm 60 mm	690 mm 27 mm	685 mm 27 mm	410 mm 16 mm	1445 mm 57 in	620 mm 24.5 in	40 kg 88.1 lbs
14 SYM3RA Symbol 3 Seat Right Arm	1710 mm 67.5 mm	690 mm 27 mm	685 mm 27 mm	410 mm 16 mm	1645 mm 65 in	620 mm 24.5 in	41.6 kg 91.7 lbs
15 SYM3LA Symbol 3 Seat Left Arm	1710 mm 67.5 mm	690 mm 27 mm	685 mm 27 mm	410 mm 16 mm	1645 mm 65 in	620 mm 24.5 in	41.6 kg 91.7 lbs
16 SYM32A Symbol 3 Seat 2 Arms	1890 mm 74.5 mm	690 mm 27 mm	685 mm 27 mm	410 mm 16 mm	1820 mm 72 in	620 mm 24.5 in	52.7 kg 116.2 lbs

Measuring Guide

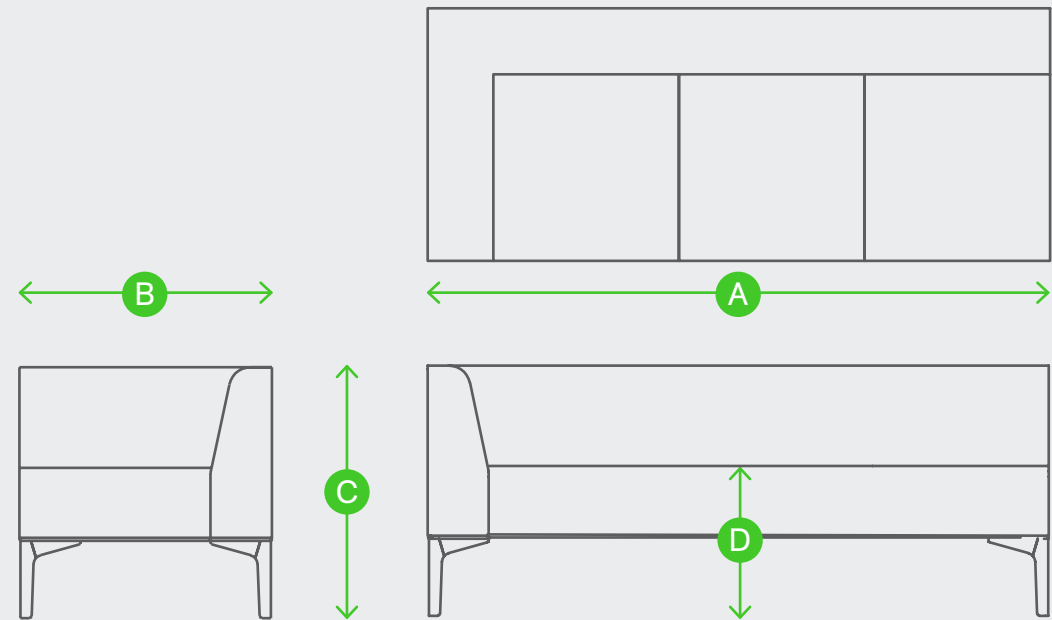

Symbol 90° Curved Seating Technical Specifications

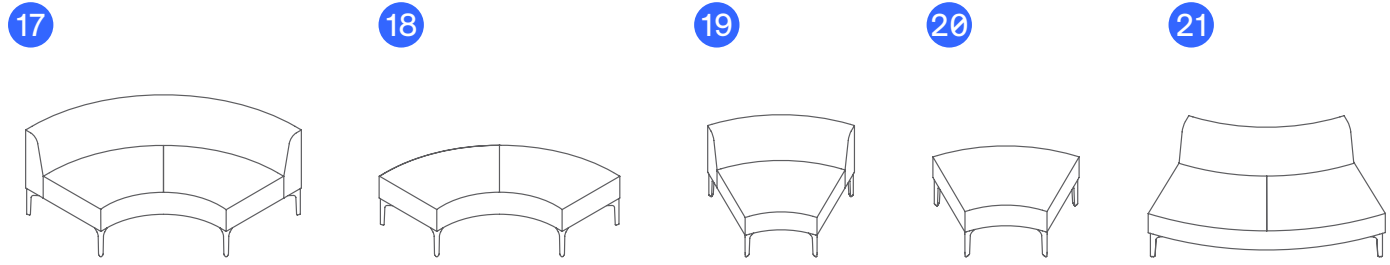

Product Code and Description <small>All dimensions quoted are rounded to the nearest 5mm or nearest 1/2 inch</small>	A Overall Width	B Overall Depth	C Overall Height	D Seat Height	E Weight
17 SYM90D Symbol 90° Curve Seat	1824 mm 72 in	866 mm 34 in	685 mm 27 in	410 mm 16 in	68 kg 149.9 lbs
18 SYM90DBEN Symbol 90° Curve Bench	1570 mm 62 in	686 mm 27 in	410 mm 16 in	410 mm 16 in	59 kg 130.1 lbs
19 SYM45D Symbol 45° Curve Seat	1025 mm 40.5 in	740 mm 29 in	690 mm 27 in	410 mm 16 in	22.6 kg 49.8 lbs
20 SYM45BEN Symbol 45° Curve Bench	890 mm 35 in	570 mm 22.5 in	410 mm 16 in	410 mm 16 in	12.6 kg 27.8 lbs
21 SYM45D Symbol External 45° Seat	1560 mm 61.5 in	785 mm 31 in	690 mm 27 in	410 mm 16 in	29 kg 63.9 lbs

Measuring Guide

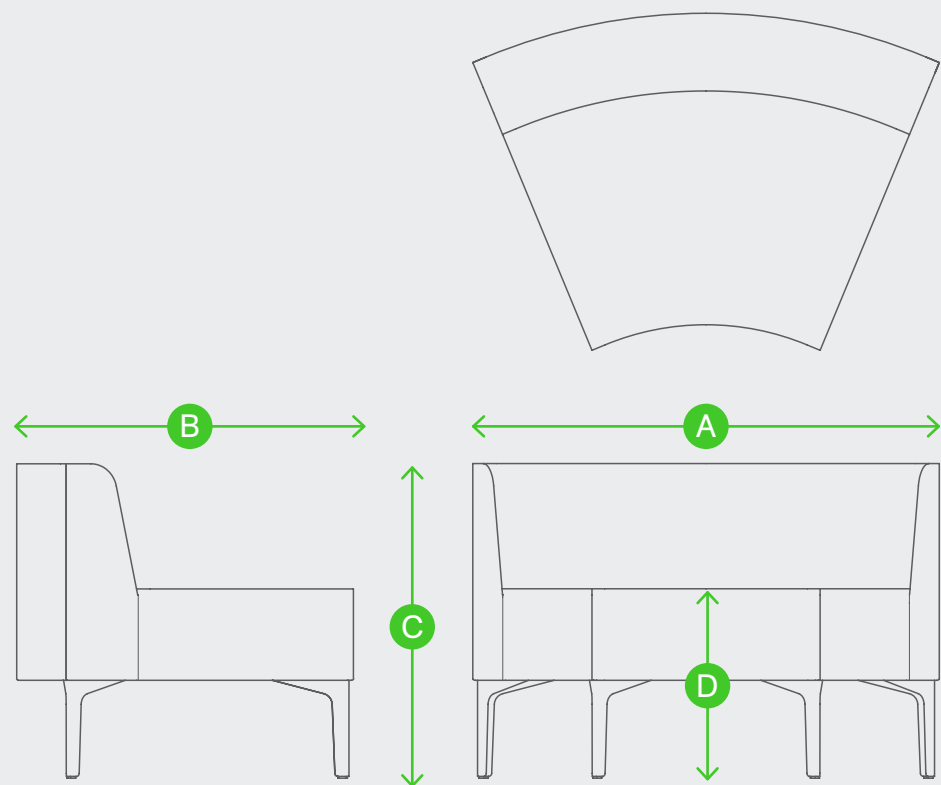

Hatch / Symbol Table Technical Specifications

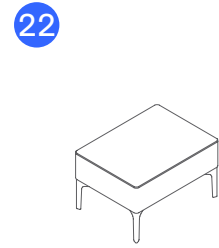

Product Code and Description <small>All dimensions quoted are rounded to the nearest 5mm or nearest 1/2 inch</small>	A Overall Width	B Overall Depth	C Overall Height	D Weight
22 HATSYMTREC Hatch / Symbol Rectangular Table	690 mm 27 in	510 mm 20 in	410 mm 16 in	15.3 kg 34 lbs

Measuring Guide

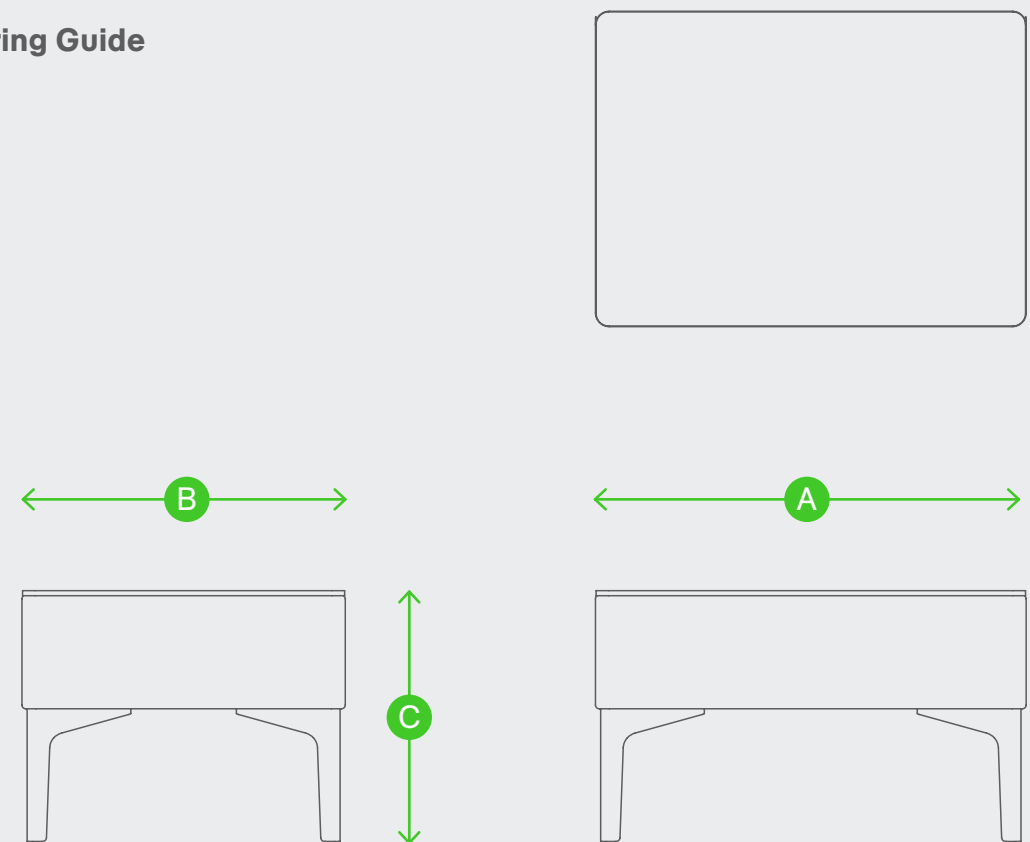

Symbol Modular Seating Environmental Product Summary



Symbol Modular Seating Environmental Product Summary

Material Percentage Split

- 77.92% Beech Plywood
- 11.45% CMHR Foam
- 5.15% Fabric
- 3.71% Mild Steel
- 0.78% Stainless Steel
- 0.63% Mild Steel Zinc Plated
- 0.35% Polypropylene

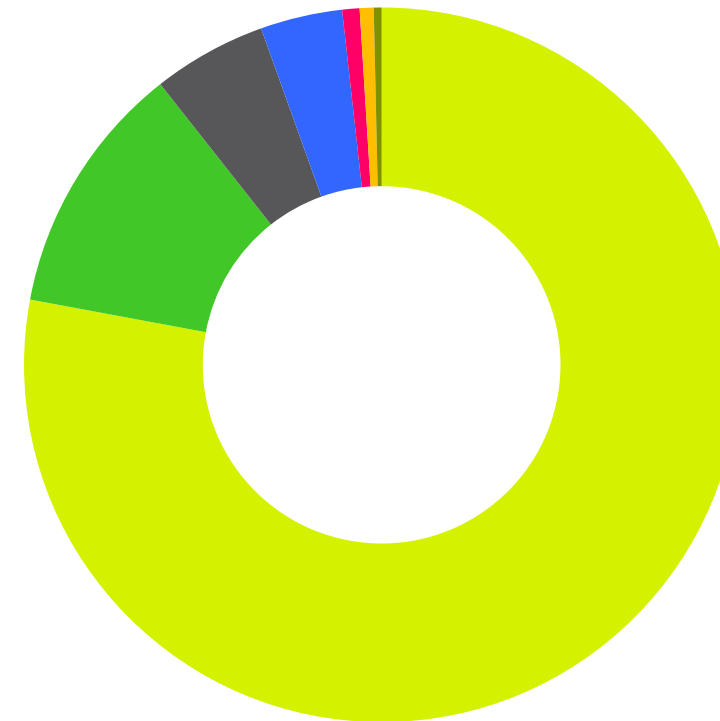

Post Consumer Recycled Content

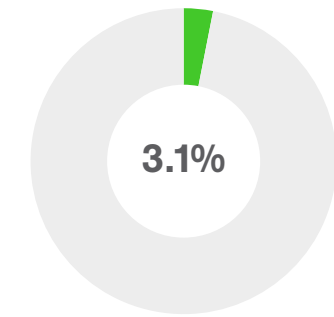

Recyclable Content

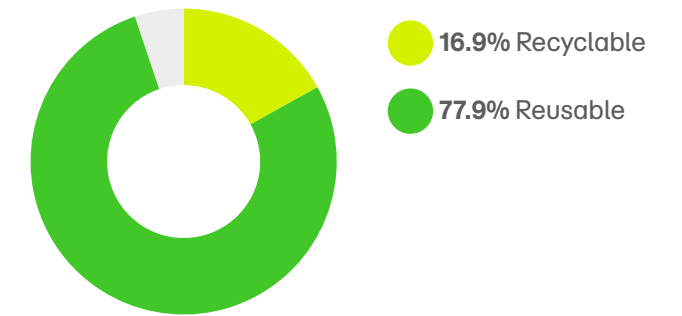

Environment Attributes

- naughtone is **FISP** and **ISO14001** certified
- naughtone is **FSC®certified**
- **43kg** total weight
- **16.9% Recyclable** (foam, legs, fixings and feet)
- **77.9% Reusable** (frame)
- **Packaging: 78.5% recycled cardboard 12.5% virgin fibre. 100% recyclable**
- **Indoor Advantage™ Gold** ANSI/BIFMA Furniture Emissions Standard (M7.1/X7.1-2011 R2016) and ANSI/BIFMA e-3-2014e (Credits 7.6.1, 7.6.2, 7.6.3)

These attributes can help you to achieve criteria towards **LEED, BREEAM, Ska** and **WELL** building certifications



CSR Statement

naughtone has always considered the environment throughout our design and manufacturing process. We understand that as we continue to grow, so does our potential impact on our surroundings. As most of our raw materials are simple, we have great control over their sources, and are proud to be able to offer **FSC®certified** upholstered products and use recycled metals in our table ranges. The addition of our North American manufacturing provision also helps to keep manufacturing miles to a minimum, as our market continues to grow in the USA. Finally, naughtone offers a 'bring back' programme, where the client is able to return the product to our factory, where we will be happy to breakdown and recycle the parts for you.

Product Specific Design Statement

The Symbol seating range has a paired down aesthetic, designed to feel like part of the architecture and provide building blocks for furniture landscapes.

Symbol sofa 2 seat 2 arms with wooden legs

With a firm upright sit and compact dimensions, Symbol is perfect for modern commercial environments where the product must look after itself and space is a premium.

Available with solid wood or steel leg options as standard and naughtone's wide fabric selection, Symbol can be tailored to suit any environment.

Symbol is constructed with a CNC plywood frame and high quality CMHR foams

The wooden legs are made from solid oak and solid walnut with a clear matt lacquered finish.

The steel legs are made from laser cut, folded mild steel with the individual laser cut components being folded allowing for minimal additional welding.

The frame components are finished with a zinc primed polyester powder coat.





1 Design

Every aspect of the naughtone product ranges has been designed with the environment considered, from ethical material choice and production efficacy to storage efficiency and ease of disassembly.

Dense foam sets and resilient fabrics are selected for their longevity and effectiveness across sectors. Durable high quality finishes such as powder coated bases in a range of colours allow clients the freedom of finish options. Finish samples are available allowing clients to make informed decisions and retain to add to their finish libraries for future reference.

2 Raw Material

Local supply of raw materials is employed for the production of our products when possible, procured from suppliers that are quality inspected for extraction methods and meet the highest environmental standards.

3 Production

As many of our products are assembled by hand the energy expenditure wasted from machinery during the production process is kept to a minimum.

All fabrics are cut to ensure optimum efficiency with fabric usage and reduced waste consumption per unit.

All production sites have recycling facilities for any excess product that cannot be used elsewhere, which is then managed by a professional third party.

4 Distribution

Distribution of naughtone products generally occurs directly between the manufacturing site to the client. Production is localised when possible to the US or UK regions, reducing the carbon footprint and miles travelled for each product.

Many items are flat packed for delivery or shipped disassembled with efficient, minimised packaging; optimizing the transportation vessel space.

5 Usage

naughtone products do not require energy or water to function, thus no environmental exchange takes place and no waste is generated during the life of the product.

The only foreseeable need is the cleaning of the product for general maintenance. This includes regular vacuuming to remove dirt and dust particles on upholstery items, and using a dry or damp cloth to wipe non-upholstery items.

This is recommended for all products utilised under conditions of normal wear and is expected to have negligible environmental impacts.

6 End of Life

Although our products are durable and demonstrate timeless design, naughtone products are manufactured in such a way that they can be easily disassembled at the end of life and most of the componentry can be either recycled or re-used as applicable.

As a company we are also happy to accept the return of products, to help re-home or recycle furniture or components at the end of the products useful life.

UK Showroom

6 Bakers Yard
Clerkenwell
London EC1R3DD
T: +44 (0)20 389 22 788

US Showroom

Suite 11-88
222 Merchandise Mart Plaza
Floor 11
Chicago IL 60654

naughtone HQ

Knaresborough Tech Park
Manse Lane
Knaresborough HG5 8LF

T: +44 (0) 1423 816 500
E: sales@naughtone.com

www.naughtone.com