

BuzziDish

INSTALLATION MANUAL

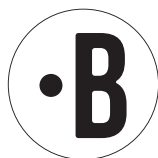

BuzziDish

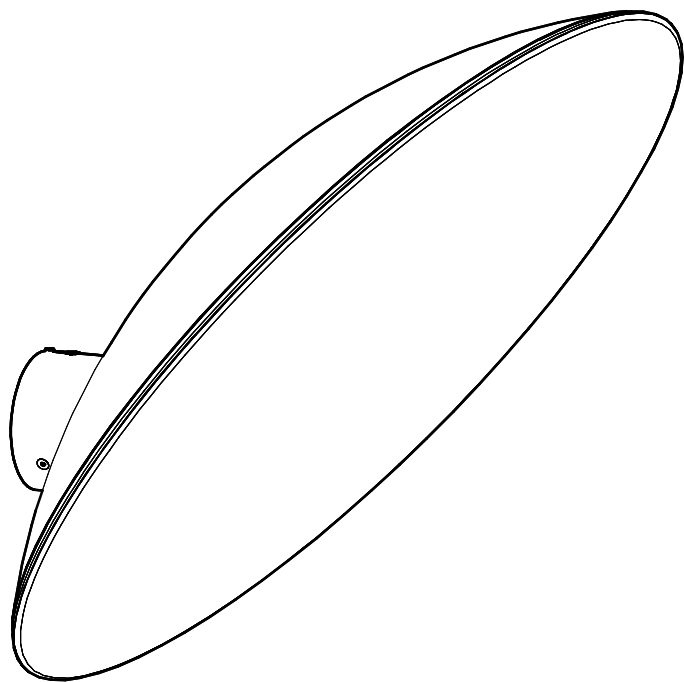
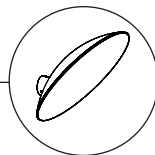

1 PERS. 

Excluded

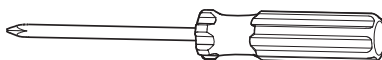
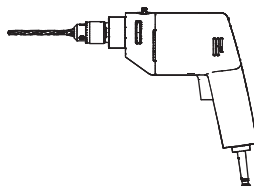

Included

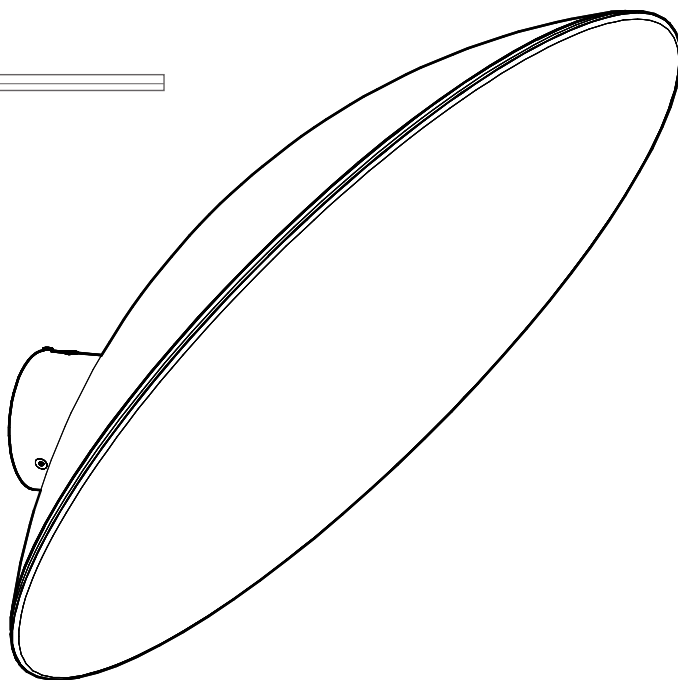

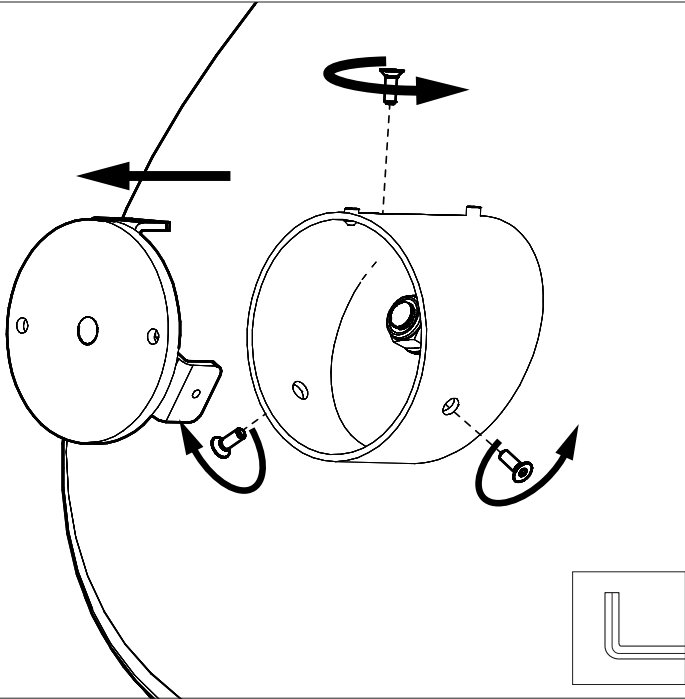
1**2**

The installer is responsible for selecting the right plug and screw, for a secure mounting of the product. Taking into account the weight of the product and the material of the mounting surface.

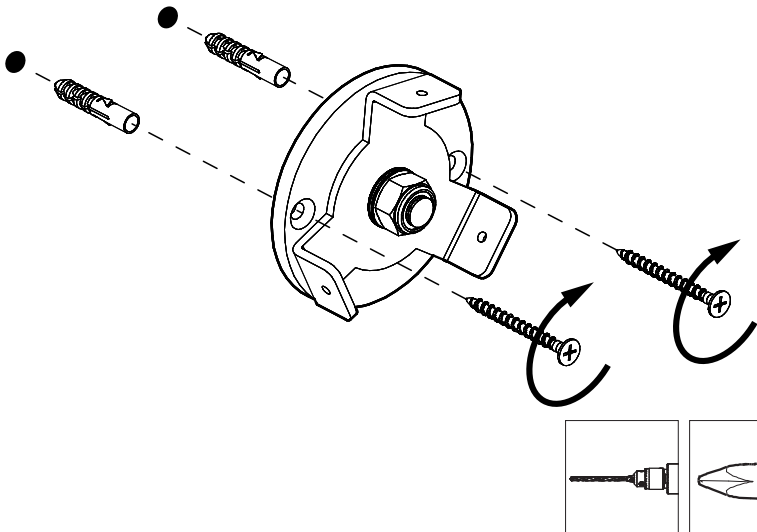

3

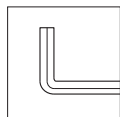
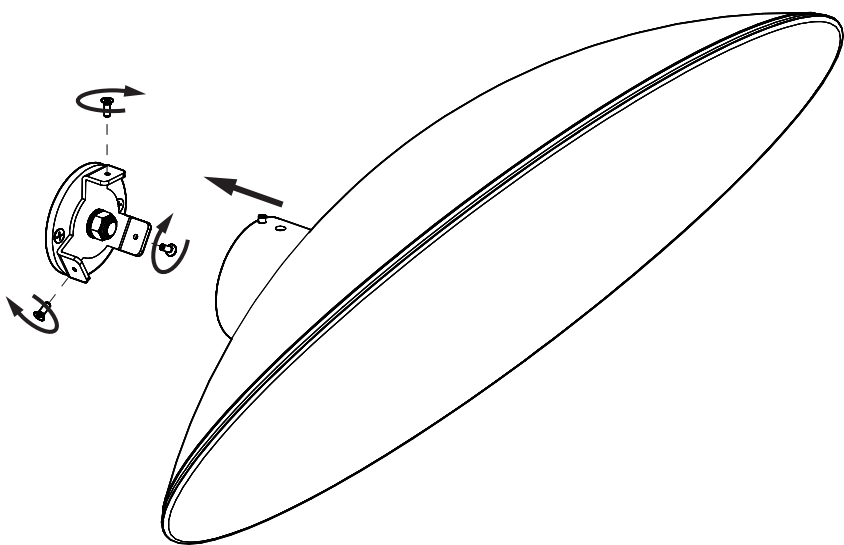

4

4

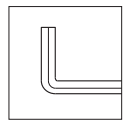
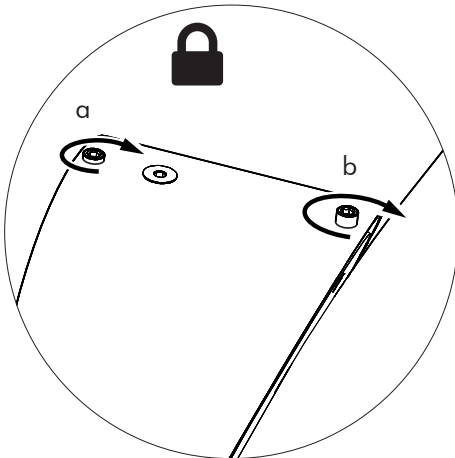
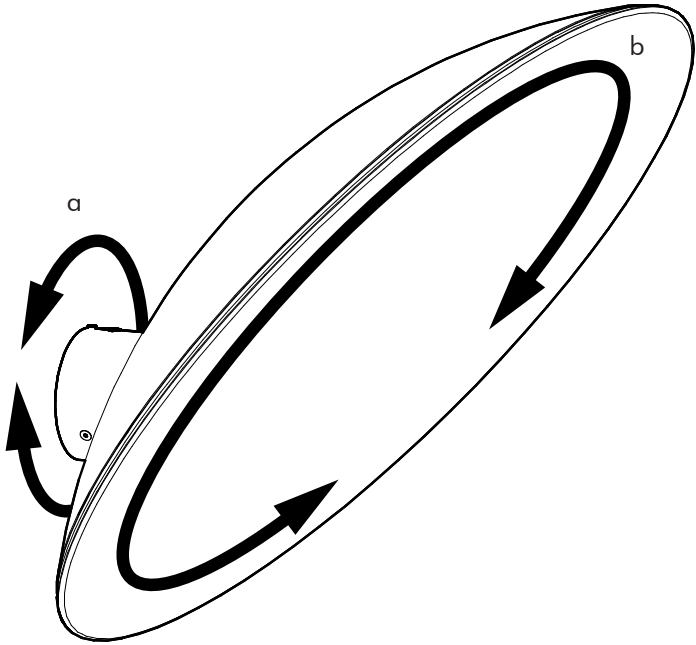

BuzziSpace Group NV
Italiëlei 8, 2000 Antwerp
Belgium

☎ +32 (0)3 846 10 00

✉ info@buzzi.space

🌐 www.buzzi.space



Doc nr.: A-0000006500/01
Last update: 01/12/2023